

CUSTOMER	NITRASOL
DRAWING No	EBE12112 Revision 0

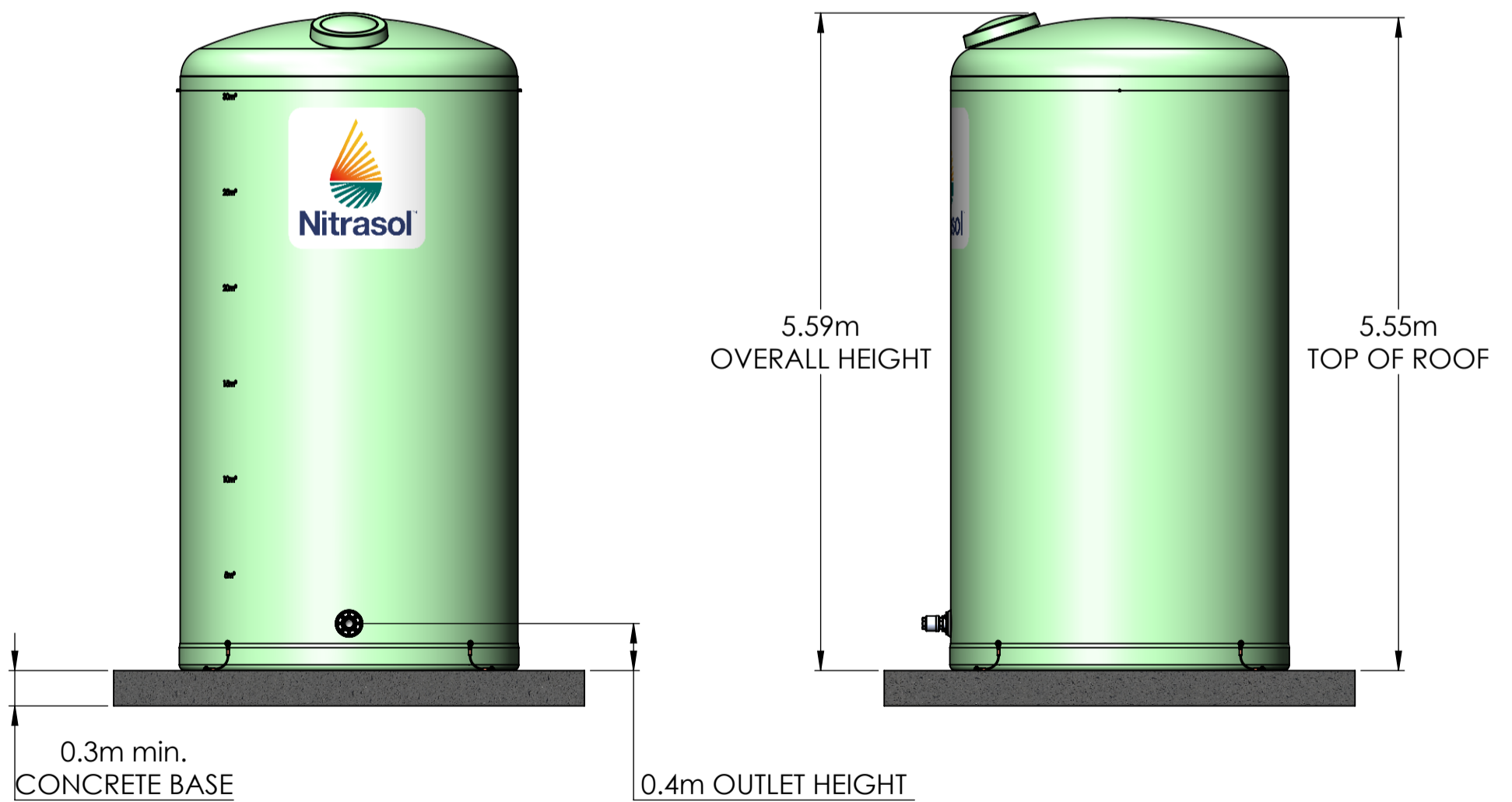
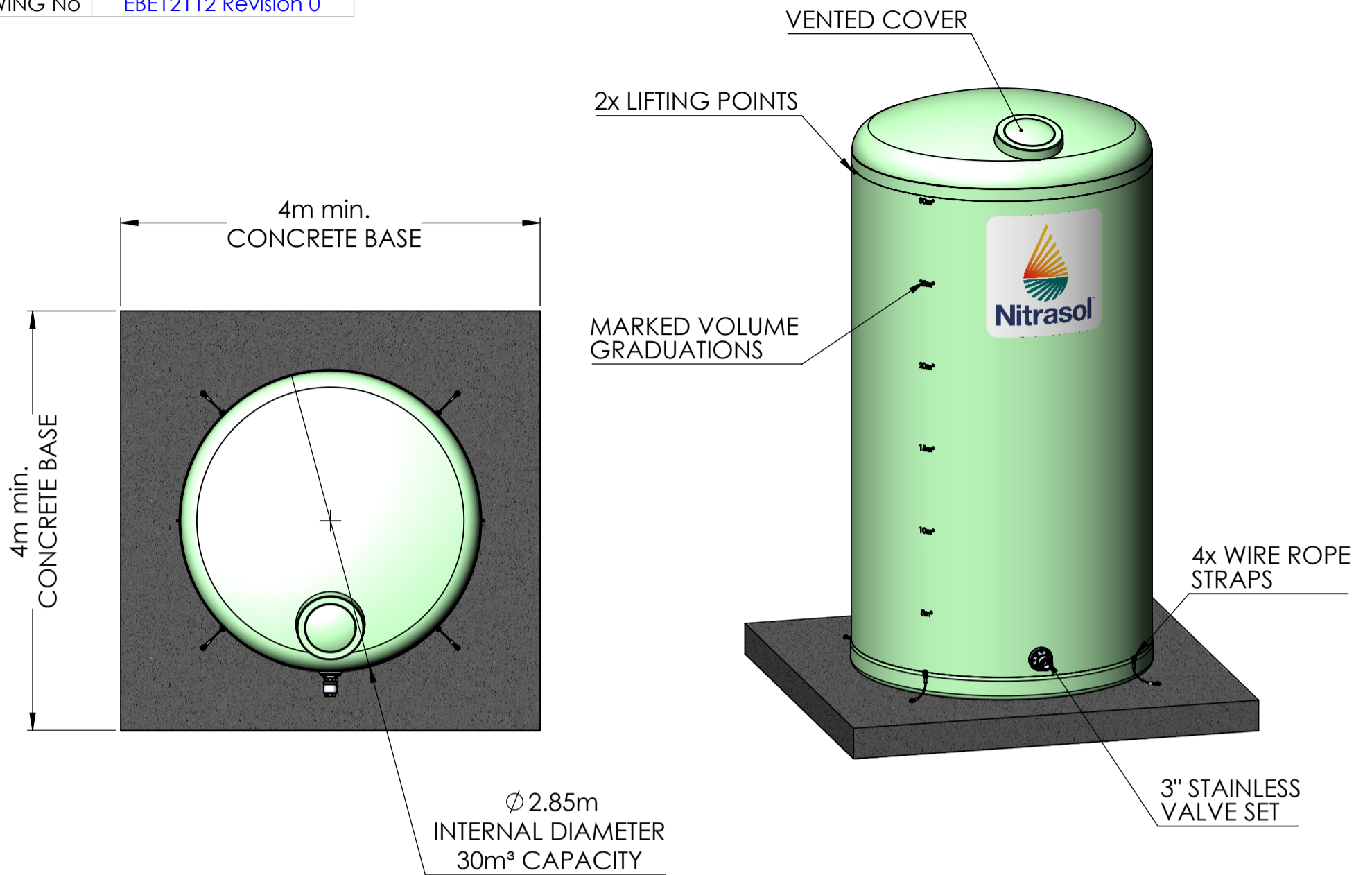

REDBROOK
BARNSELY
SOUTH YORKSHIRE
S75 1HR
Tel : 01226 730037
Email : info@eb-equipment.com

The information contained within this drawing is the property of EB Equipment Ltd. Any reproduction in part or as a whole without the written permission of EB Equipment Ltd is prohibited

DESCRIPTION

Ø2.85m 30Cu.M FLAT BOTTOM TANK